

INSTALLATION INSTRUCTIONS

Item# P1905-66A-L (Rev. 11/10/2023)

READ AND SAVE THESE INSTRUCTIONS

WARNING! SHUT POWER OFF AT FUSE OR CIRCUIT BREAKER.
AVERTISSEMENT! COUPER LE COURANT AU NIVEAU DES FUSIBLES OU DU DISJONCTEUR.

PREPARATION

1. Carefully remove the fixture from the carton and check that all parts are included as shown in the illustration.
2. Shut off power at the circuit breaker and remove the old fixture including the mounting hardware.

MOUNTING THE FIXTURE (FIG. 1)

1. To retract wire, gently push it into light fixture base. To extend wire, push metal collar while gently pulling wire down. When the metal collar is released, the wire will be fixed into position. Now turn fixture over and slide plastic wire retainer up to hex nut of canopy, as a secondary safety precaution to prevent fixture from slipping down when in use.
2. Loosen mounting plate screws (E) to remove mounting plate (B) from canopy (D).
3. Attach mounting plate (B) to outlet box (Not included) using outlet box screws (C) (Size: #8-32N*L1"L) as shown in Fig.1. Make sure side of mounting plate marked "GND" must face out.

CONNECTING THE WIRES (FIG. 2)

4. Connect the electrical wires as shown in Fig. 2, making sure that all wire connectors are secured. If your outlet has a ground wire (green or bare copper), connect fixture's ground wire to it. Otherwise, connect fixture's ground wire directly to mounting plate (B) using green screw provided.
5. After wires are connected, carefully tuck them inside outlet box.

FINISHING THE INSTALLATION (Fig.1)

6. Mount canopy (D) onto mounting plate (B) and secure it with mounting plate screws (E).

Your installation is now complete. Return power to the outlet box and test the fixture.

Note: Illustration (Fig. 1) on this manual is for installation purpose only. It may or may not be identical to the fixture purchased.

Dimmable with ELV and/or LED compatible wall dimmer switch.

Fig.1

Set #A-010-113

- Mounting Plate
- Ground Screw
- Outlet Box Screw*2
- Mounting Plate Screw *2

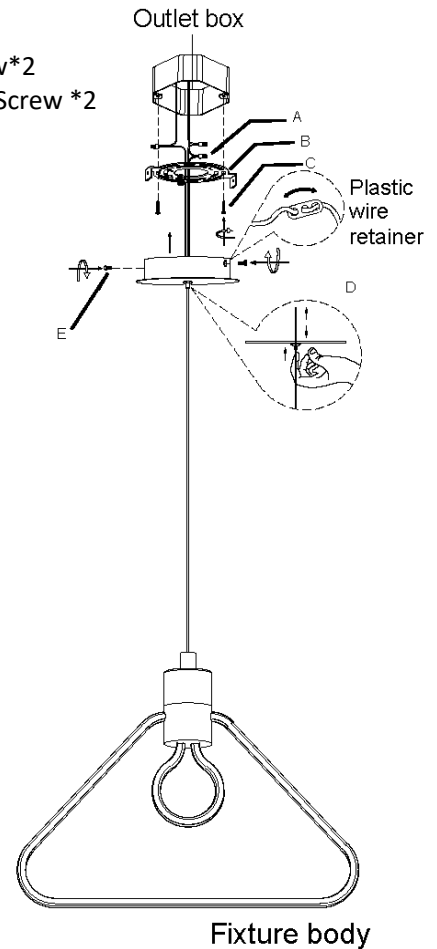
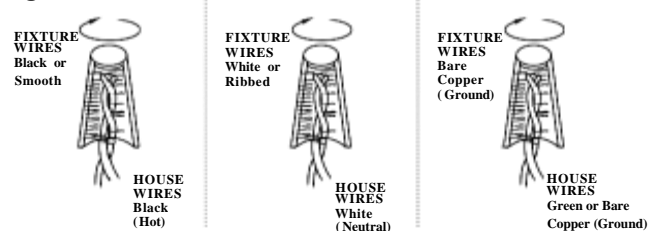

Fig.2



IMPORTANT: FIXTURE SHOULD BE INSTALLED BY A QUALIFIED ELECTRICIAN TO ENSURE PROPER WIRING AND INSTALLATION.

